

PUST175X75

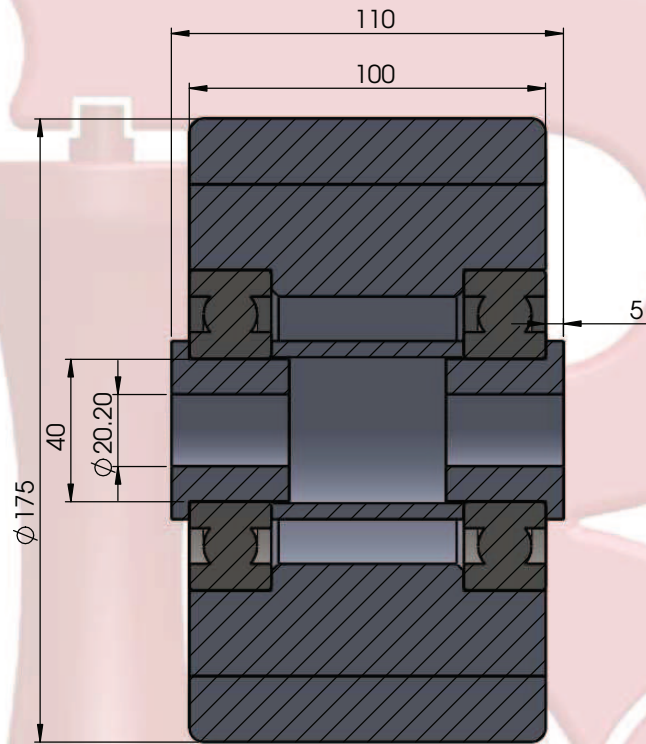

PUST175X100

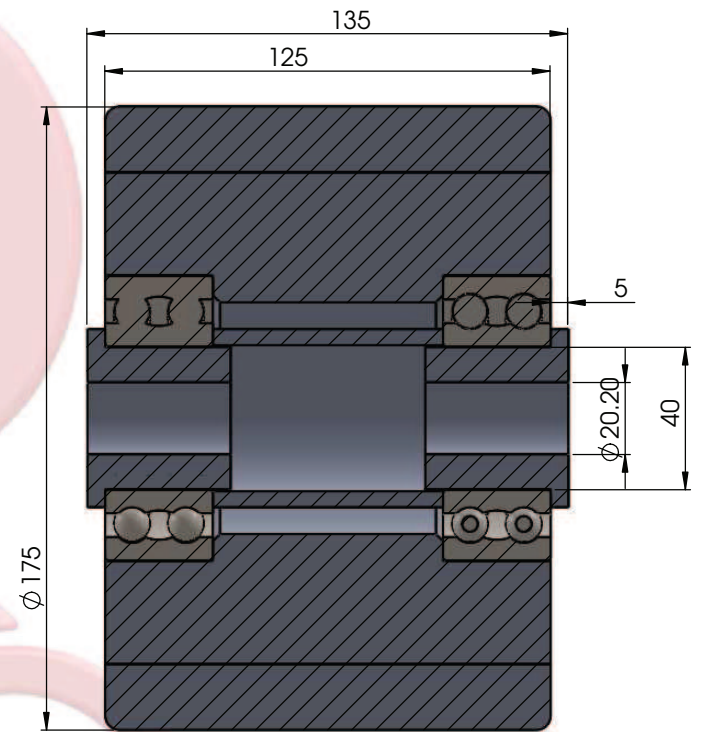

PUST175X125

CUSTOMER APPROVAL:

COMPANY:
SALES PERSON:
NAME:
SIGN:
DATE:

DO NOT SCALE DRAWING	REVISION	FINISH:
----------------------	----------	---------

PROPRIETARY AND CONFIDENTIAL
 THE INFORMATION CONTAINED IN THIS DRAWING IS THE SOLE PROPERTY OF Richmond Wheel & Castor Co. ANY REPRODUCTION IN PART OR AS A WHOLE WITHOUT THE WRITTEN PERMISSION OF Richmond Wheel & Castor Co. IS PROHIBITED.

	NAME	SIGNATURE	DATE
DRAWN	BREON	BWM	14/10/2019
CHKD	SY	SY	14/10/2019
APPVD	RAY	RW	14/10/2019
MFG	SY	SY	14/10/2019
Q.A	BARRY	BN	14/10/2019

UNLESS OTHERWISE SPECIFIED:
 DIMENSIONS ARE IN MILLIMETERS
 TOLERANCES TO 0.25MM

DEBUR AND
 BREAK SHARP
 EDGES



TITLE:
**RICHMOND WHEEL &
 CASTOR CO.**

DWG. NO. PU TYRED STEEL CENTRE
 WHEELS 175MM

A3

WEIGHT:

SHEET 6 OF 13